

2 REQUIRED  
(MIRROR OPP.)

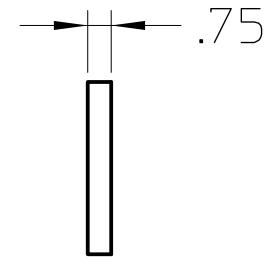

FACE

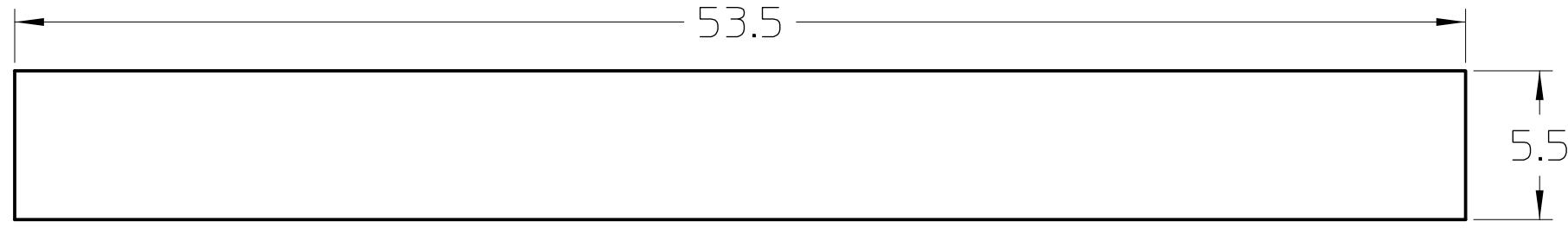
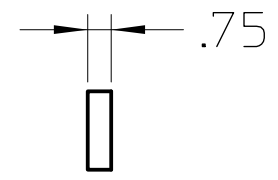
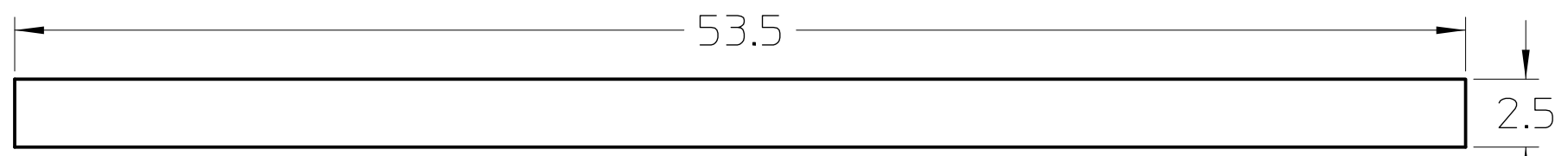

OUT-SIDE

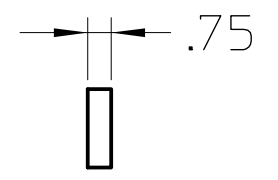
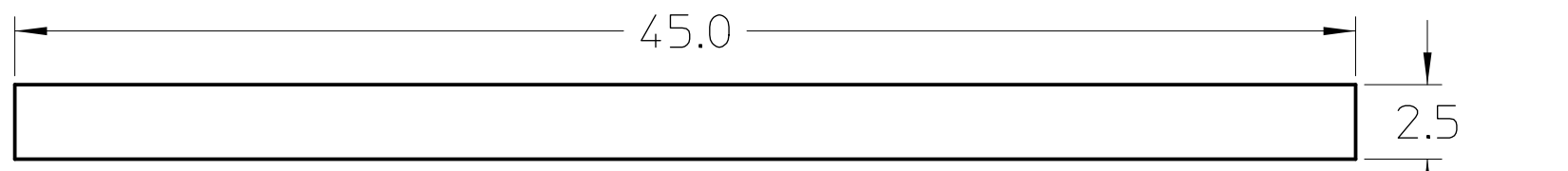

IN-SIDE

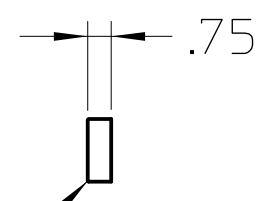
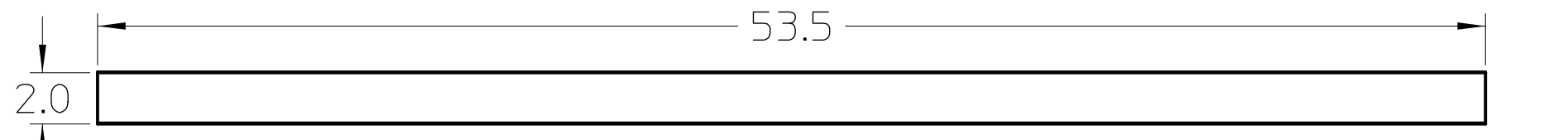

VERT TRIM (2 REQ.)

2X 45°x.03

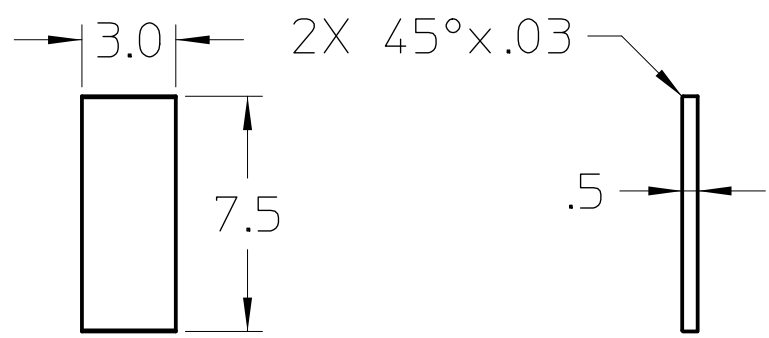

BASE

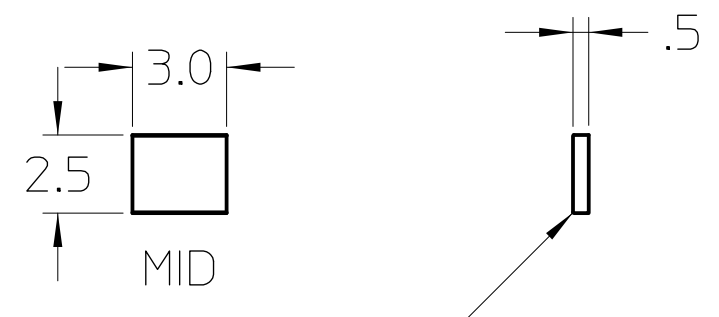

MID

2X 45°x.03

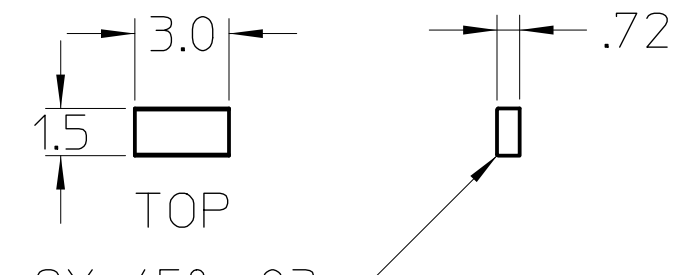

TOP

2X 45°x.03

2

1

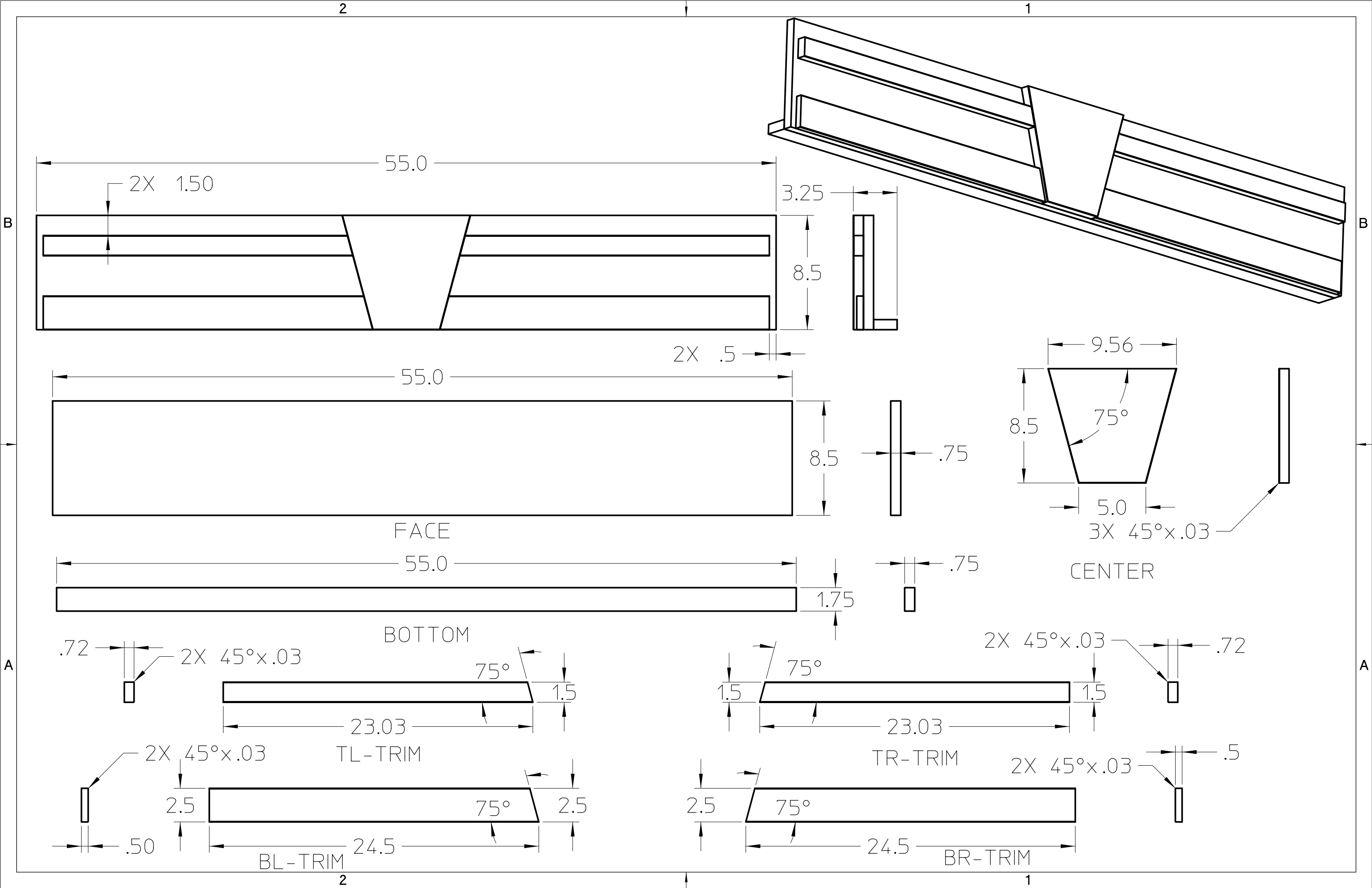

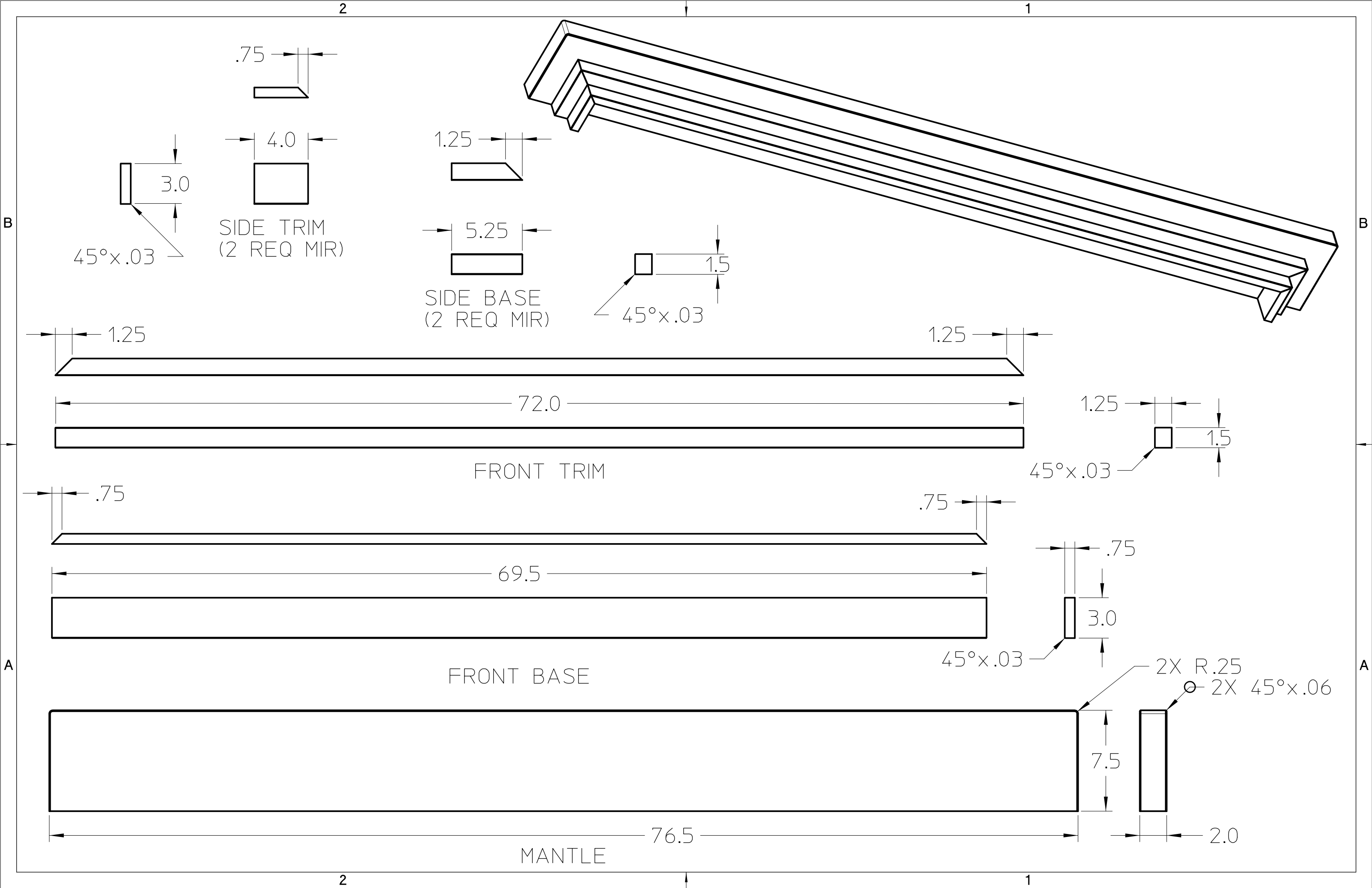

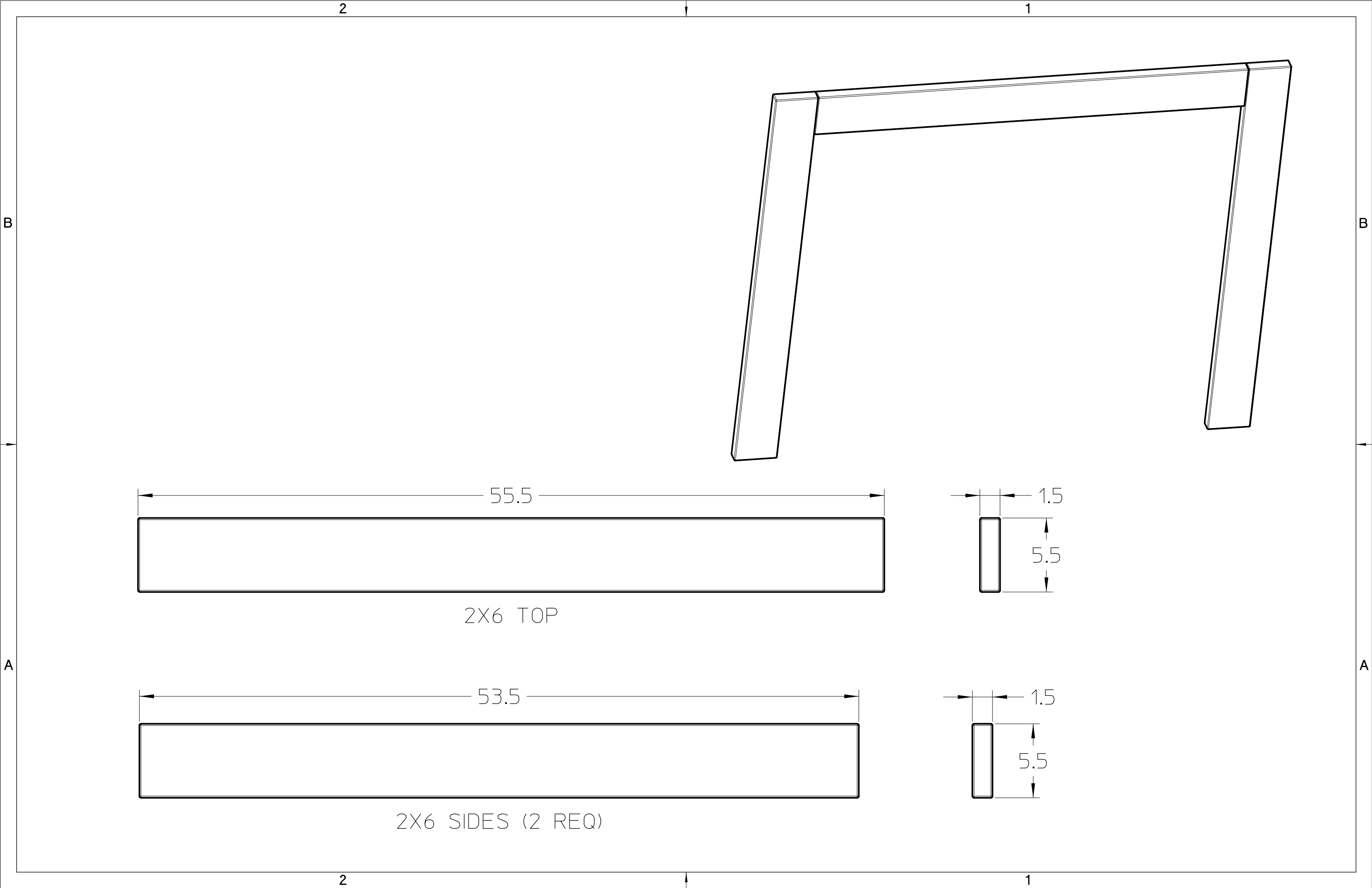

2

1

B

B

A

A

55.5

1.5

5.5

2X6 TOP

53.5

1.5

5.5

2X6 SIDES (2 REQ)

2

1